

Quality Solutions for Air Cargo Handling

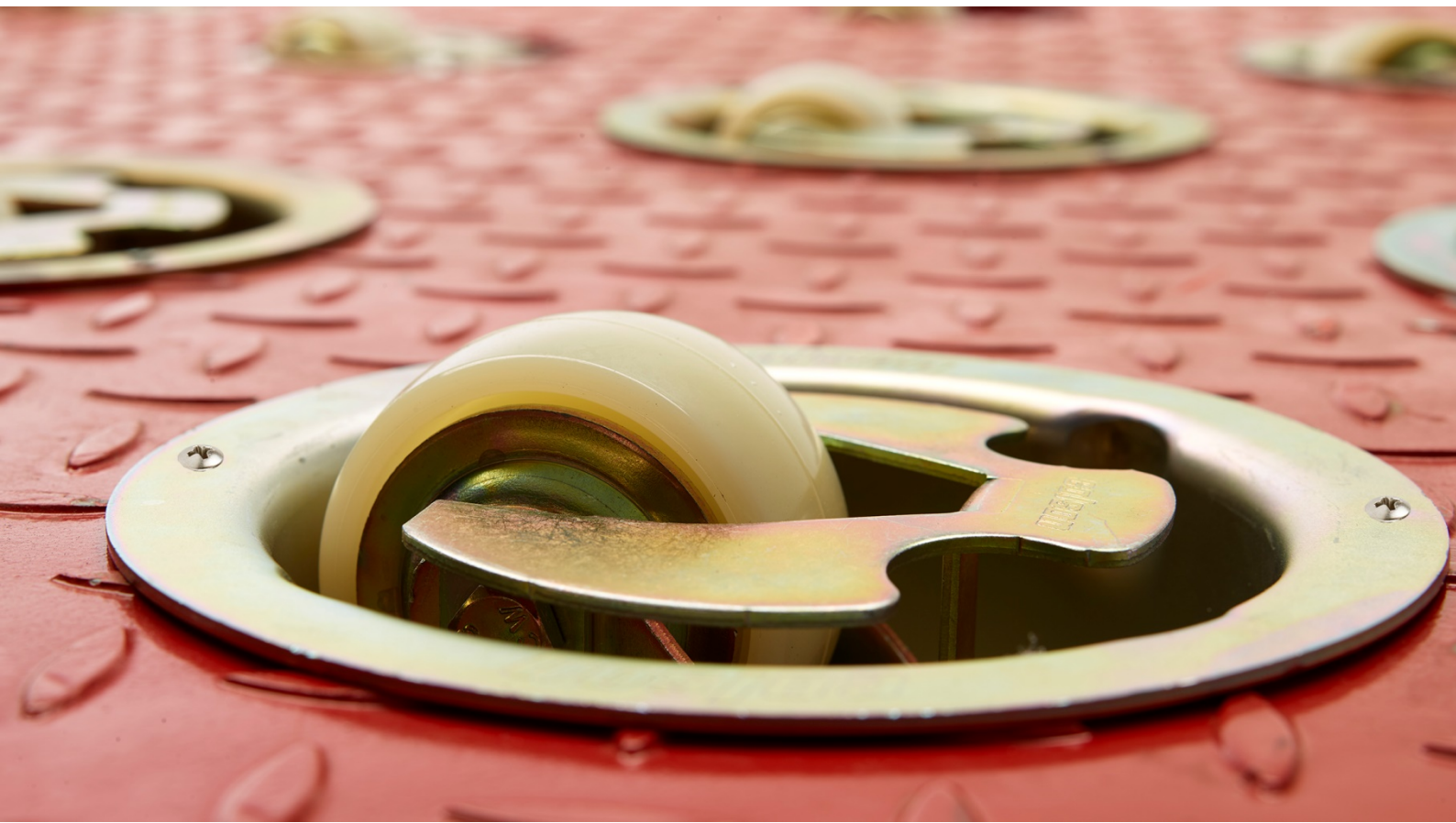

colson
Colson Europe B.V.

Colson Europe Cargo Castors



Cargo Castors are essential components used in ULD handling environments at airports worldwide. You can find our silent and maintenance free products in logistic cargo centers. But also on Ground Support Equipment (GSE) like dollies and loaders on the ramp our products are used intensively.

The current Colson Europe BV Cargo Castor is a result of continuous development and improvements. We emphasized our products for the extreme conditions found in ULD handling. This results in a product which endures the shock, load and temperature fluctuations at airports worldwide more than any other product. Even in perishable-cool storage facilities our product feel at home.

Composition of a Standard Cargo Castor



- A** toe-guard
- B** special engineered low wear impact-resistant polyamide 6.6 wheel
- C** maintenance free sealed ball bearing
- D** plastic sealing cap drains water and prevents corrosion
- E** integrated steel thread guard protects prevents blocking of the wheel
- F** robust deep drawn pressed steel fork with special anti-corrosion zinc coating
- G** labyrinth-seal protects the swivel head for dust and water

The Colson Europe Cargo Castors are

- extreme wear and shock-resistant
- enabling real easy handling over a long period of use
- absolute maintenance free for its full lifetime
- guaranteed worldwide use all over the years by its premium quality

Standard cargo castors



Standard Cargo Castors are used mainly on dollies and loaders

Cargo Castors with toe-guard



A **toe-guard** prevents operators to step into the holes present in the top deck area while walking over them, pushing the ULD's.

The applicable H&S regulations usually enforce the use of these preventive devices



Standard cargo castors with attached toe-guard are generally used on decks and occasionally on dollies and loaders as well



Standard cargo castors with attached toe-guard are generally used on decks.

Cargo Castors

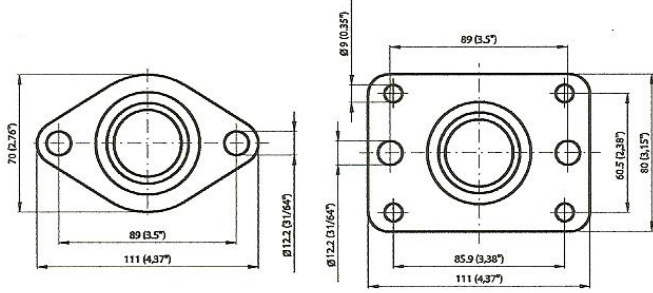
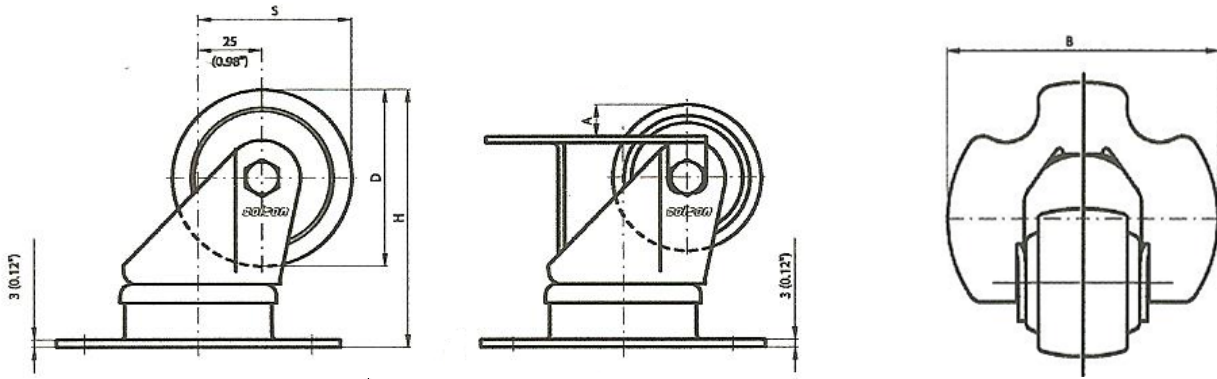





diamond top plate

rectangular topplate

Castor load capacity : 250 kg
 Standard temperature range : -30°C to +80°C
 We advise to mount our products onto a flat and sturdy mounting surface to ensure a rigid support for the complete topplate area of our castors.





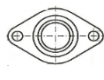
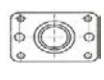

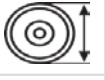

Standard Cargo Castors

						
	D	B	H	S	diamond	rectangular
	mm	mm	mm	mm		
JBPN 058-CC1/A	58	35	96	54	X	
JBPN 058CC1/A-R	58	35	96	54		X
JBPN 070-CC1/A	70	35	102	60	X	
JBPN 070-CC1/A-R	70	35	102	60		X



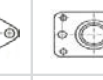





Standard Cargo Castors with attached toe-guard

								
	D	B	H	S	diamond	rectangular	A	B
	mm	mm	mm	mm			mm	mm
JBPN 058CC1/AT12,7	58	35	96	54	X		12,7	107
JBPN 058CC1/A-RT12,7	58	35	96	54		X	12,7	107
JBPN 058CC1/AT16	58	35	96	54	X		16	107
JBPN 058CC1/A-RT16	58	35	96	54		X	16	107
JBPN 070CC1/AT12,7	70	35	102	60	X		12,7	107
JBPN 070CC1/A-RT12,7	70	35	102	60		X	12,7	107
JBPN 070CC1/AT18,7	70	35	102	60	X		18,7	107
JBPN 070CC1/A-RT18,7	70	35	102	60		X	18,7	107
JBPN 070CC1/AT22	70	35	102	60	X		22	107
JBPN 070CC1/A-RT22	70	35	102	60		X	22	107

Cargo Castors



Standard Cargo Castors with integrated toe-guard

								
	D		H	S	diamond	rectangular	A	B
	mm	mm	mm	mm			mm	mm
JBPN 058/2187171	58	35	96	54		X	19	120
JBPN 058CC1/ATLP16	58	35	96	54	X		16	107
JBPN 058CC1/ARTLP16	58	35	96	54		X	16	107
JBPN 070CC1/ATLP22	70	35	102	60	X		22	107
JBPN 070CC1/ARTLP22	70	35	102	60		X	22	107

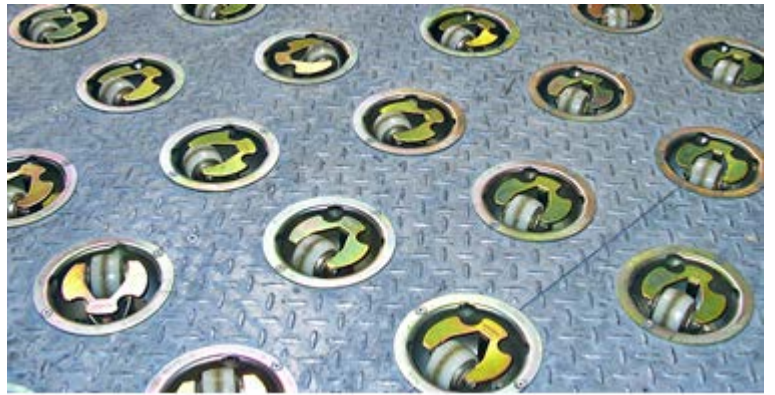

Mobra

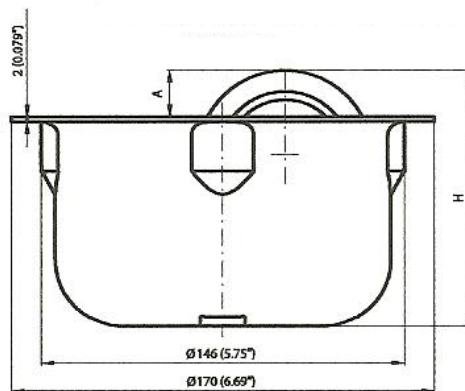
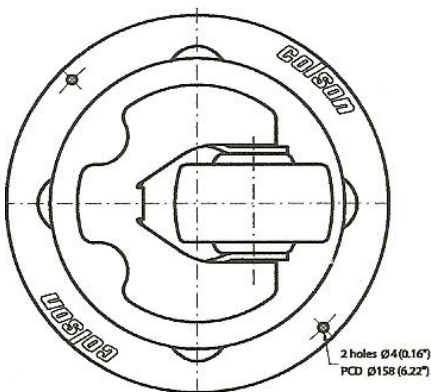

Mobra mounting bracket with a standard cargo castor and an attached toe-guard

- Ease of installation and replacement
- Cost-effective construction of the deck - the castor is simply put into a top-deck which on its own requires sufficiently support obviously.
- A precise height adjustment between top and lower deck during construction isn't required.
- Clean deck - debris cannot fall under the deck area. This is highly beneficial in debris intensive environments and perishable handling situations.



						
	D		A	H	S	kg
	mm	mm	mm	mm	mm	
MBPN 058 MOBRA	58	35	12,7	98	54	200
MBPN 070 MOBRA	70	35	18,7	104	60	200



Worldwide No. 1



The Colson Group produces worldwide wheels and castors for many industrial applications. Colson Europe B.V. in Veenendaal, The Netherlands is particularly known for producing top quality Cargo Castors. Apart from these, we also supply castors for Air Craft Docking systems, Hose support castors on Fuel trucks and many other GSE applications.



Our main catalogue contains more than 200 pages of castor solutions for all your applications. Please phone or e-mail us to get the hardcopy catalogue or download a copy on our website.

Colson Europe B.V.
3900 AK Veenendaal
The Netherlands

tel. +31(0)318 53 66 11
mail info@colson-europe.com
website www.colson-europe.com